

RAK811 NEW PIN

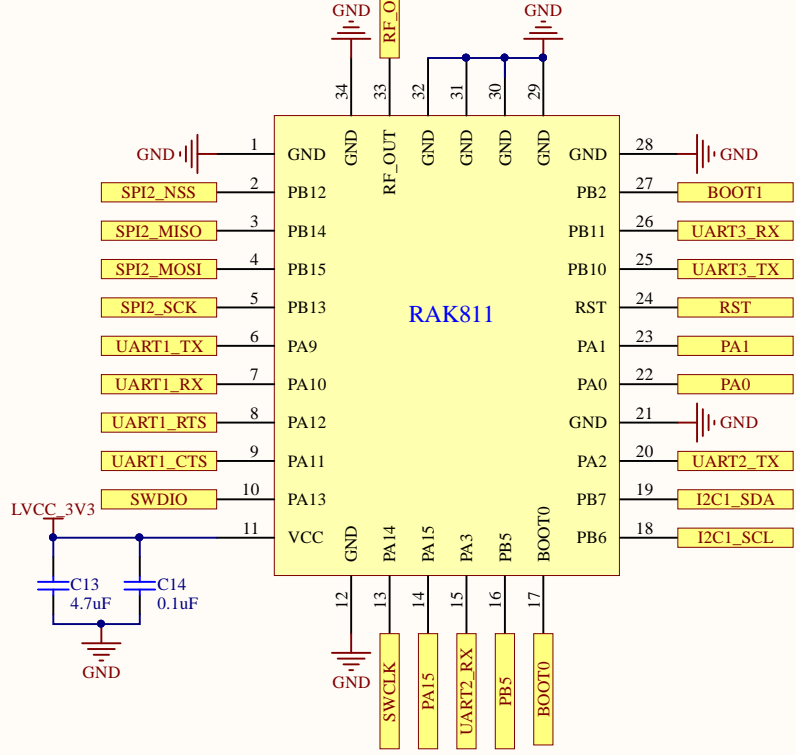

mikroBUS

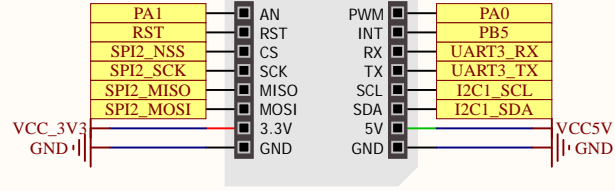

RF OUT

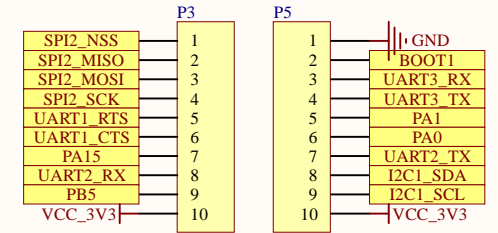
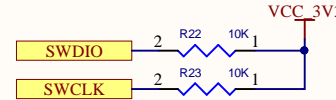
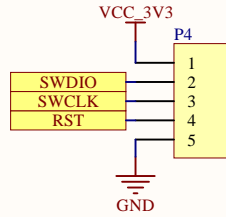
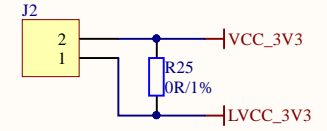
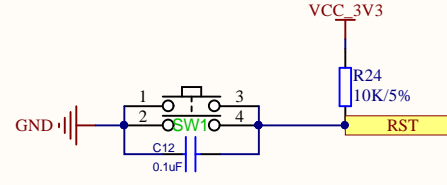
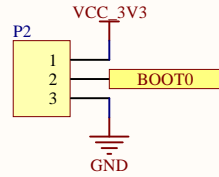
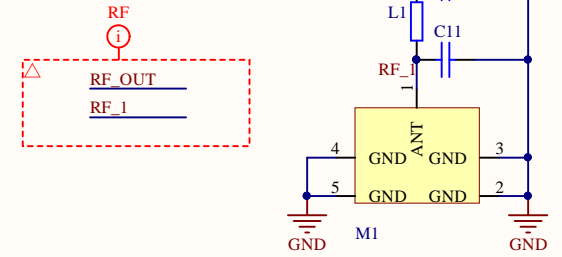

Title		
Size	Number	Revision
A4		
Date:	2020/3/28	Sheet of
File:	D:\PCB_design\RAK811.SchDoc	Drawn By:

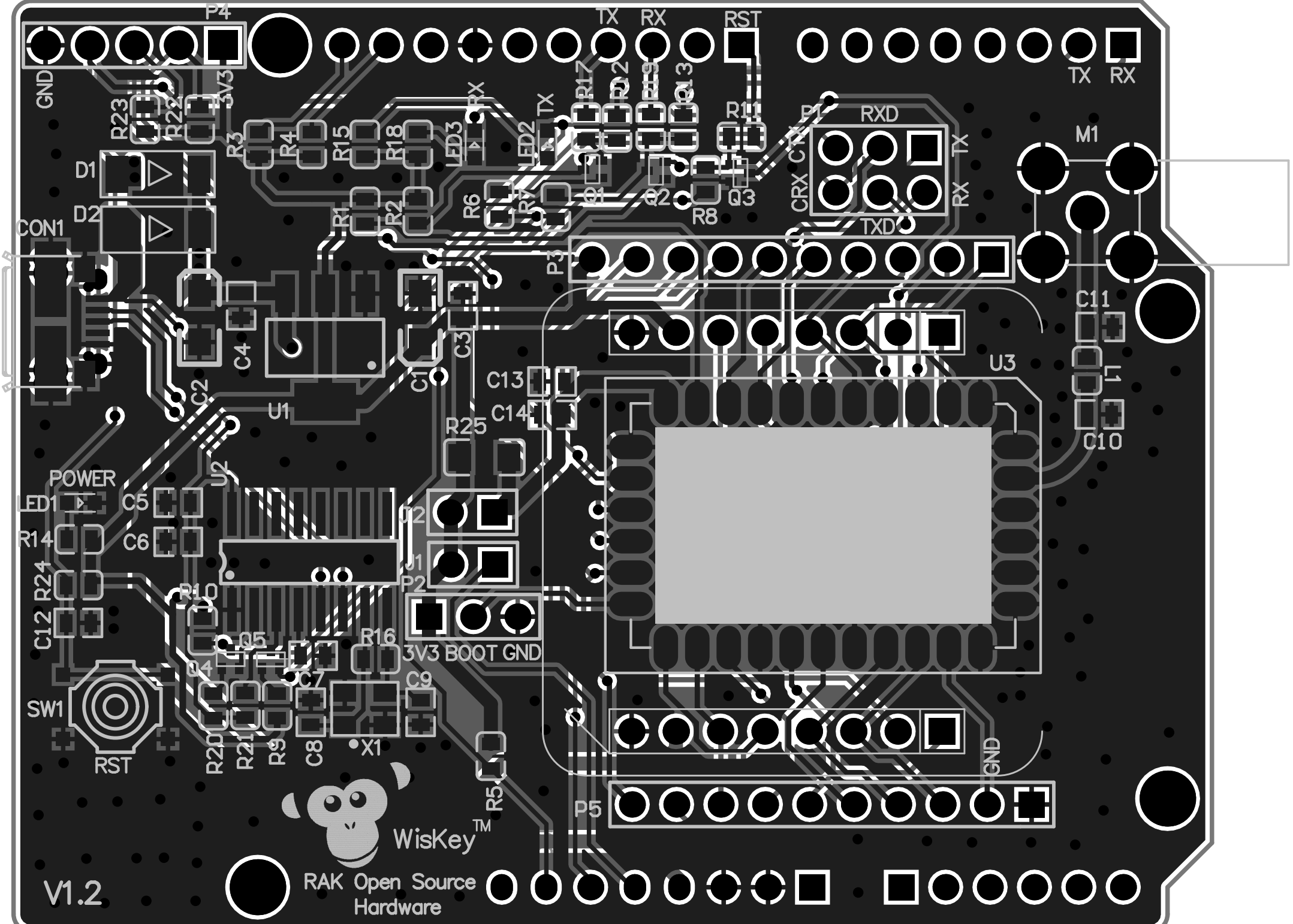

V1.2



WisKey™

RAK Open Source Hardware