

The WisMesh Pocket V2 is a ready-to-use device for the Meshtastic LoRa® mesh network, pre-flashed with Meshtastic firmware. Equipped with advanced features like a GNSS module, acceleration sensor, and 1.3" OLED display, it's ideal for off-grid communication and tracking.

For this device use Meshtastic
firmware-rak4631-w.x.yy.zzzzzz.uf2

Package Contents

WisMesh Pocket V2 × 1
LoRa Antenna x 1
USB Cable x 1

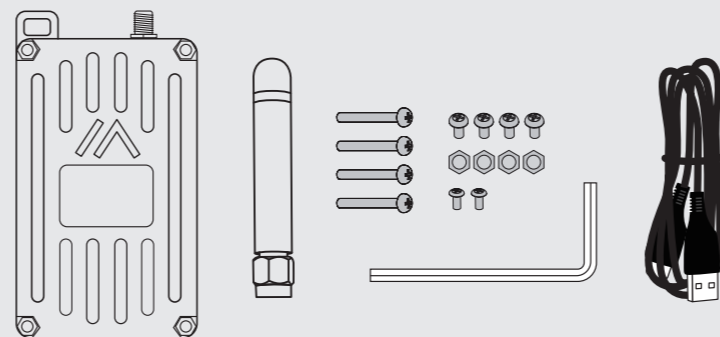

Need More Information?

For detailed product specifications, configuration guides, and technical support, scan the QR code on the right to access our online document center. Stay up to date with the latest resources and troubleshooting tips to get the most out of your device.



Scan for WisMesh Pocket V2
Documentation

Getting Started

Step 1

- Remove cap
- Screw on LoRa antenna

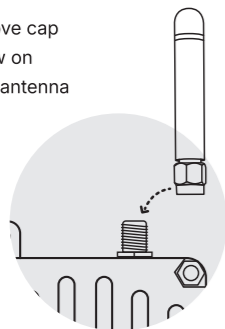

Step 2

- Insert USB-C
- Plug to an adapter or a PC

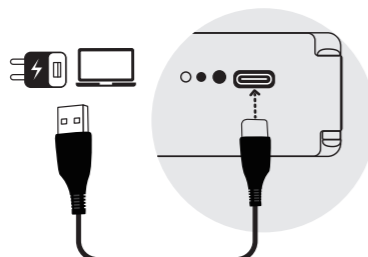

Step 3

- Toggle switch
- Wait 5 seconds
- Screen lights up

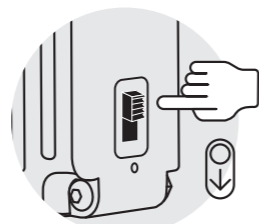

Step 4

- Download/open Meshtastic App
- Pair with the device

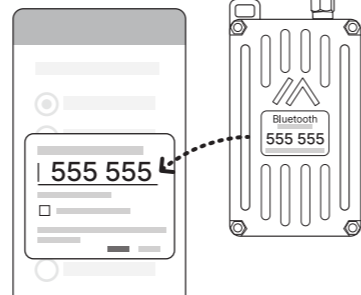

Step 5

- Select your region

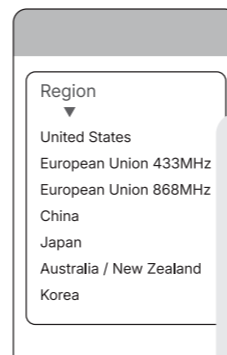

⚠ The device will NOT function and the right button will NOT be responsive until the region has been set via the Meshtastic App.

Step 6

- Press right button to navigate

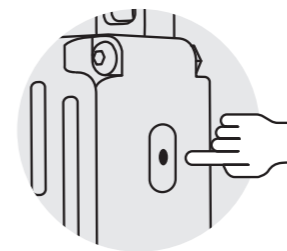

LED Lighting Indications

RED: charging
GREEN (solid): powered on
GREEN (breathing): BLE DFU mode
GREEN (blinking): MCU activity
BLUE: new message



Welcome to WisMesh

This guide helps you set up your Meshtastic device in minutes.

Thanks for choosing WisMesh
— A RAKwireless Product